

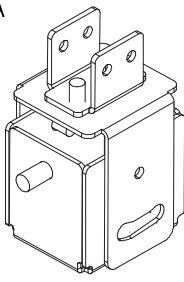

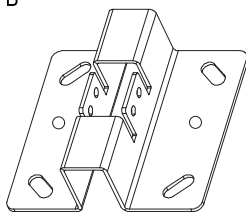

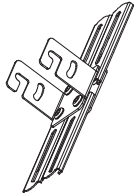

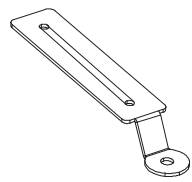

מתקן תלייה תקרתי למקרן אוניברסלי צמוד קיר

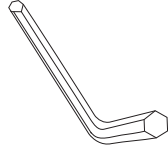
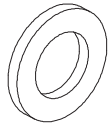
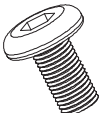
Component List

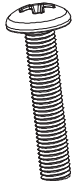
 <p>connect component x1</p>	 <p>mounting platex1</p>	 <p>connect componentx1</p>	 <p>connect componentx4</p>	 <p>connect componentx2</p>	 <p>allen wrench x1</p>		
 <p>5x10x1 x4</p>	 <p>M5x8 x13</p>	 <p>spacer x4</p>	 <p>M4x12 x4</p>	 <p>M3x10 x4</p>	 <p>expansion bolt M6x60 x4</p>	 <p>M6x4</p>	 <p>M6x10 x4</p>

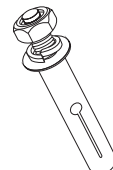
Installation



Notice

This projector mount should only be installed on concrete or brick wall with provided screws .

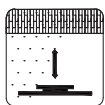
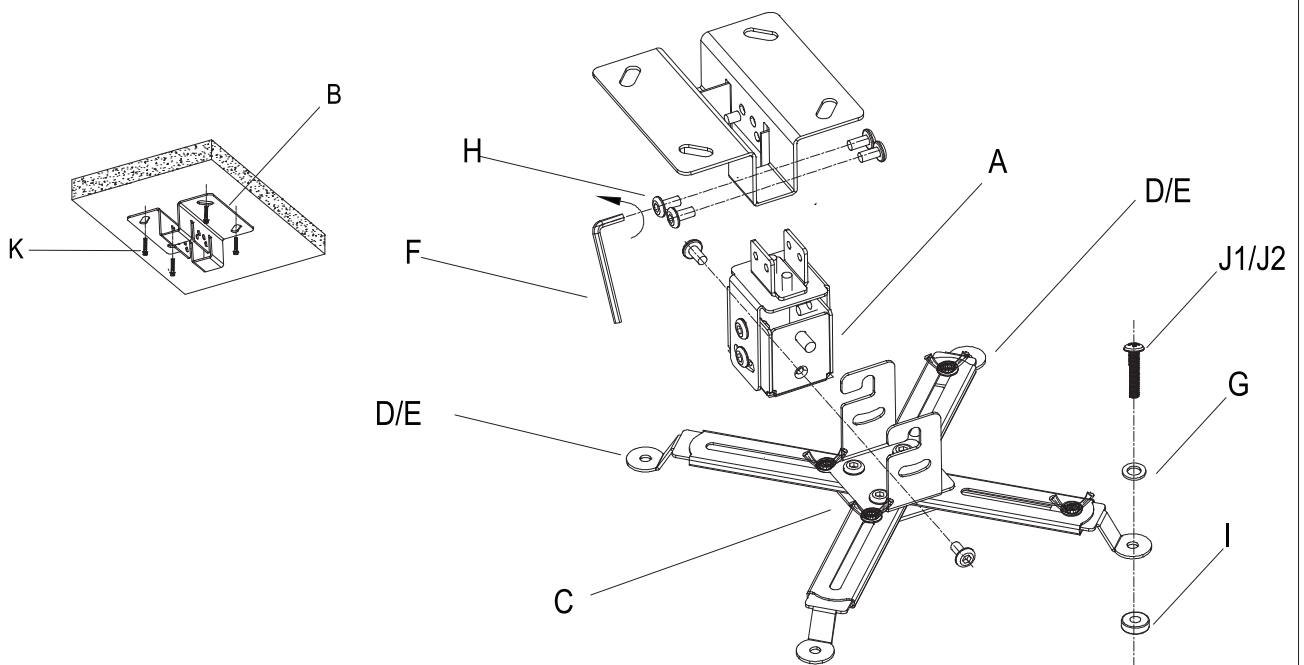

WALL DISTANCE
120mm

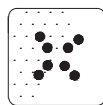

HOLE SITE
Max 370mm

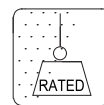

TATED LOAD
50kg/110lbs